

# Cleantech Forum Lahti

## 5.-6.6.2006

**Claim Your share of the Distributed  
Power Generation business**

**Reijo Takala  
Managing Director  
Verteco Oy**



- § Verteco Oy was established 26.2. 2003.
  - § Founders: Vacon Plc, Semikron GmbH and Verteco Management
  - § Investors: Power fund I Ky (VNT Management)
  
- § Verteco operates in the Distributed Power Generation and Power Quality businesses

# Power Converter

3

- § Power converters are used to match the uncontrolled nature of variable speed generator (e.g. wind turbine) to the fixed voltage/frequency grid.
- § Modern power converter technology outperforms all other wind turbine technologies in energy capture and grid code compliance.

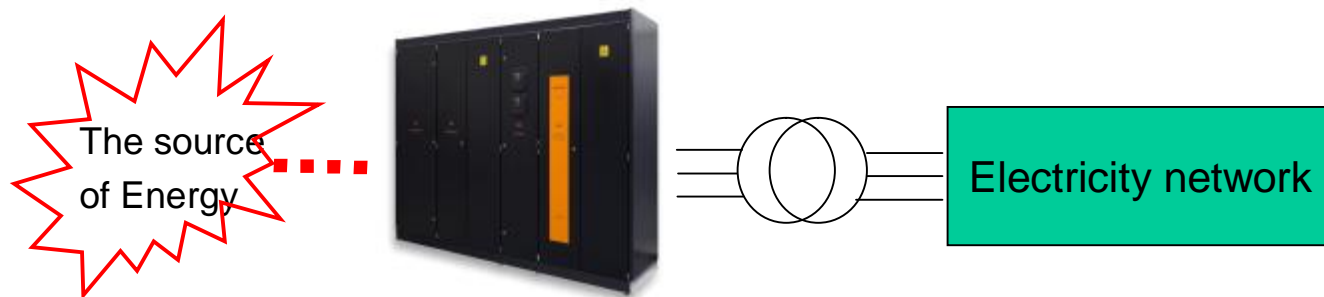

# Verteco Oy decision to focus on wind power

4

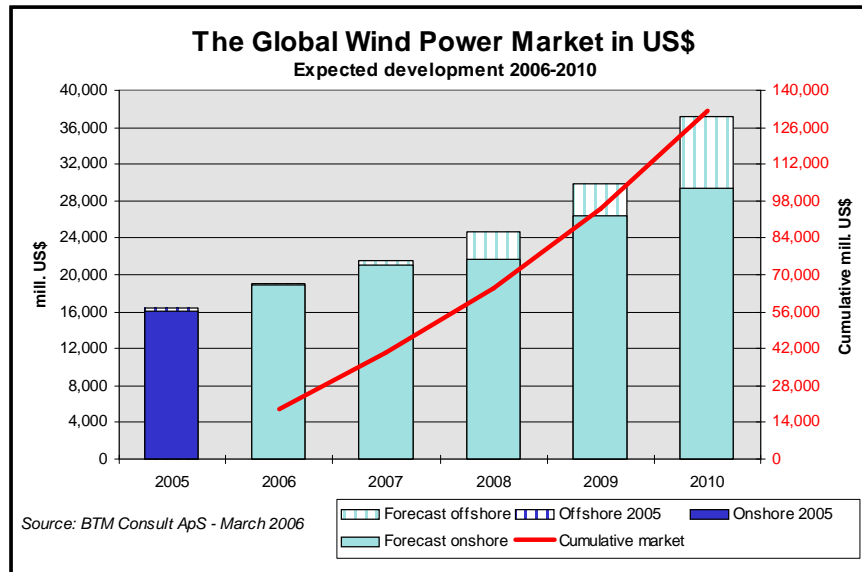

§ Decision to focus on wind power

§ Existing

§ Growing

§ Technology change

§ Decision to specialise on high power (>1 MW) full size solutions

Year	Installed MW	Increase %	Cumulative MW	Increase %
2000	4,495		18,449	
2001	6,824	52%	24,927	35%
2002	7,227	6%	32,037	29%
2003	8,344	15%	40,301	26%
2004	8,154	-2%	47,912	19%
2005	11,407	40%	59,264	24%
<b>Average growth - 5 years</b>		<b>20.5%</b>		<b>26.3%</b>

Source: BTM Consult ApS - March 2006

§ Technology suitable also for other applications

29.5.2006 Verteco for Wind Power



# Wind power market

5

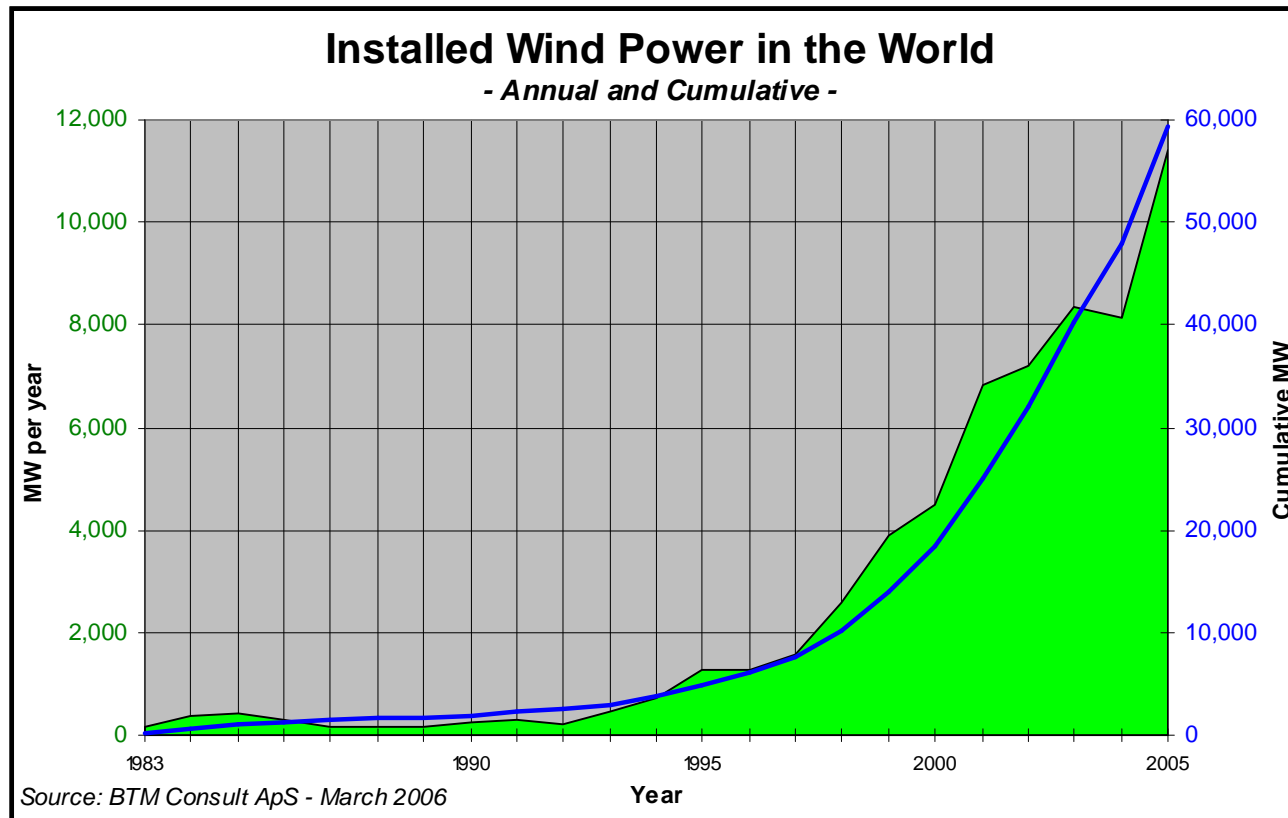

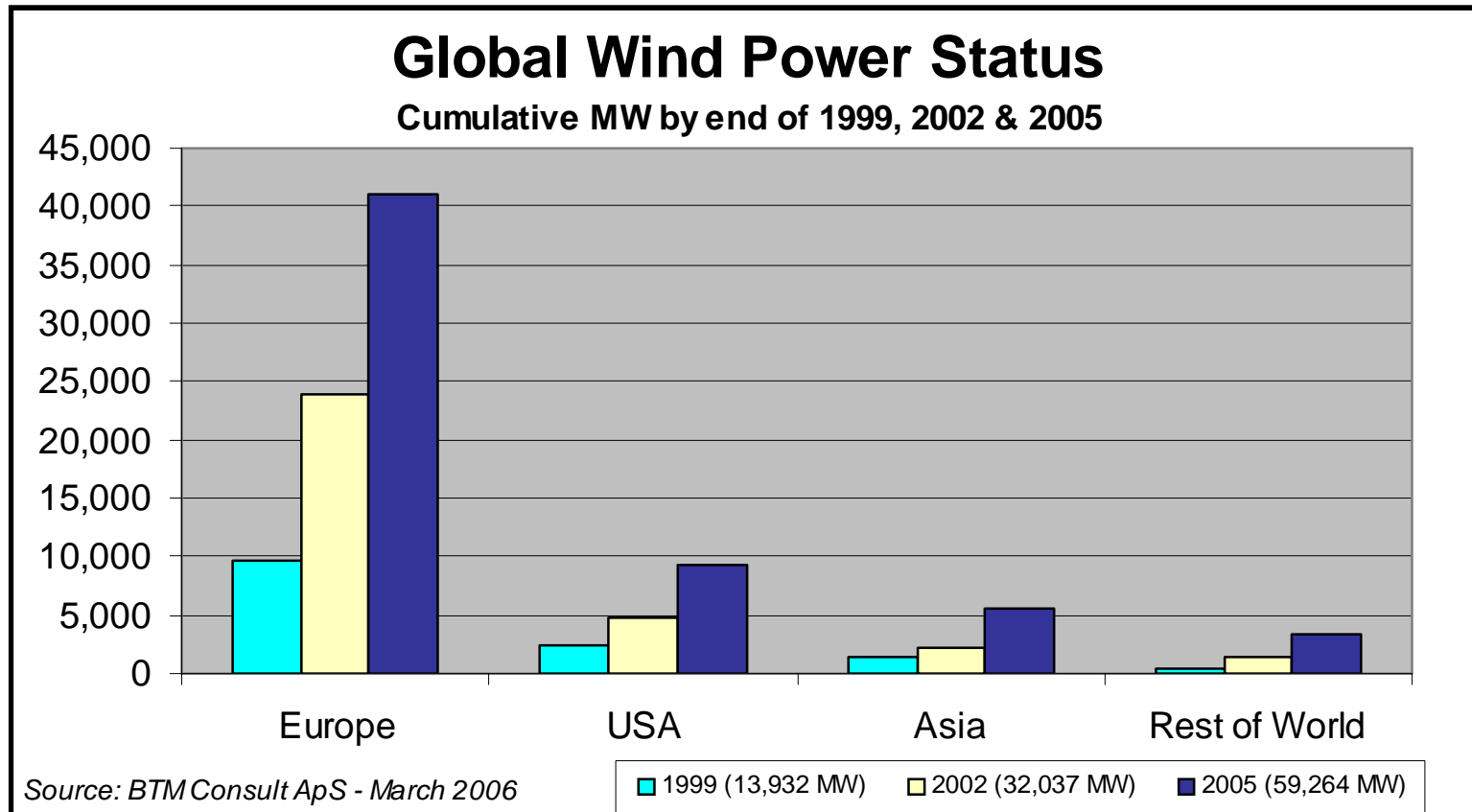

# Wind power market

7

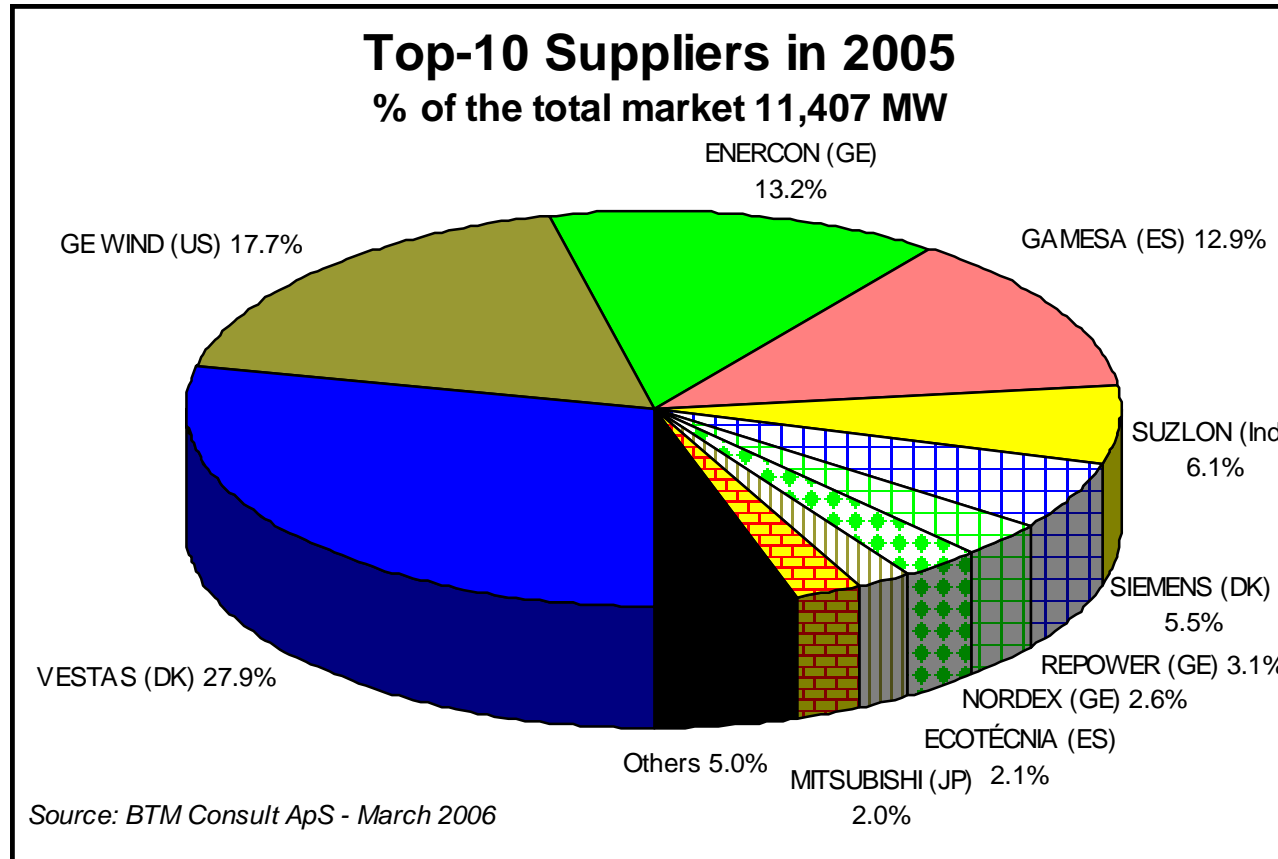

# Verteco Oy is networking

8

§ Verteco Offers a full blown solution and the related services by networking with the top players in the market



§ Verteco understands the needs of the market and develops its products accordingly





- § Verteco utilizes world class Vacon inverters as the engine of its products.
- § Industrially mass produced Vacon inverters have very good track record in reliability.

# Power train for a 3,5 MW Wind Turbine

11

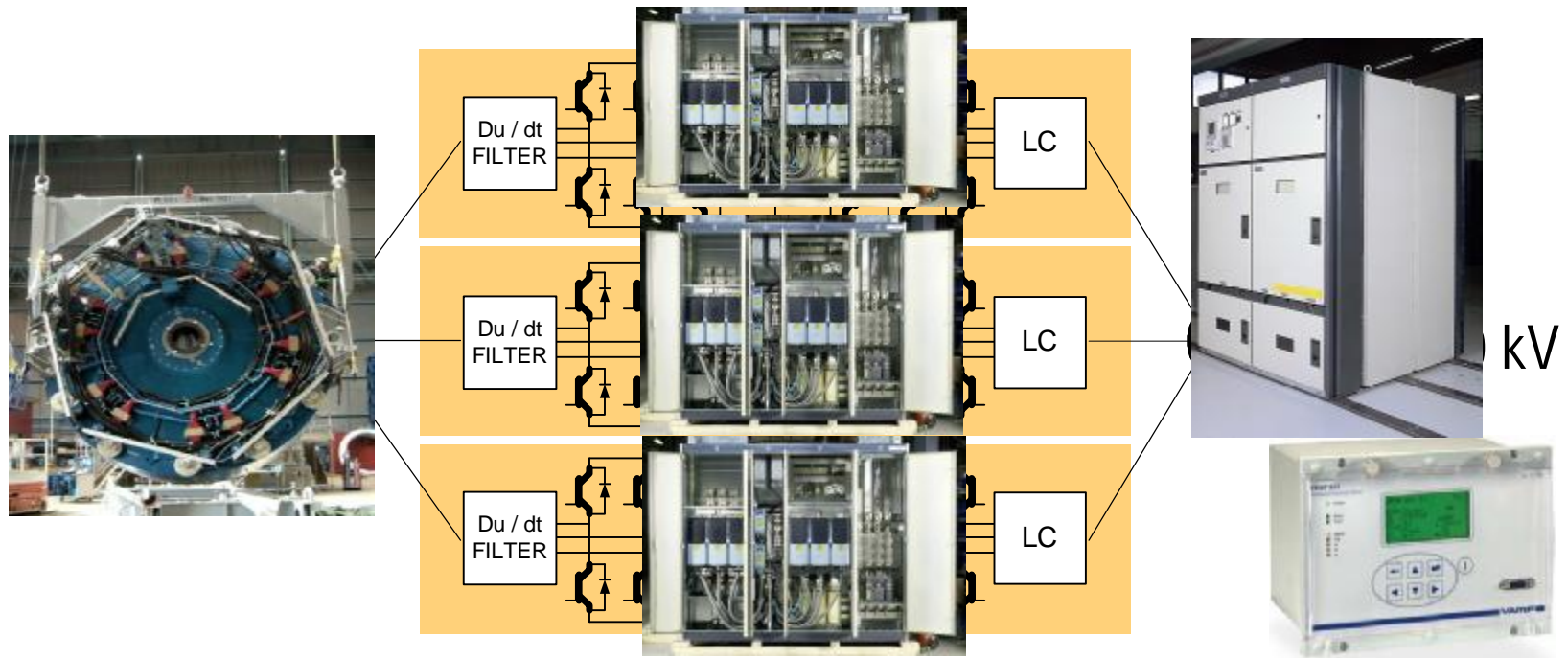

§ Year 2005 positive net result

§ Personnel 12

§ Aiming at fast growth

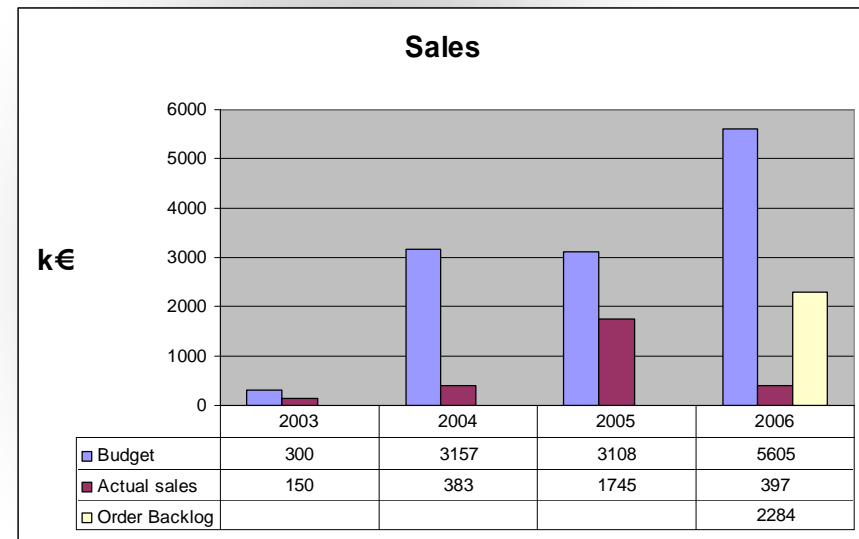



- § Winwind, 1 MW & 3 MW
- § Scanwind, 3 MW & 3.5 MW
- § European customer, 1.5 MW
- § Asian customer, 1.5 MW
- § European customer 250 kW

Verteco is the leading supplier for full power wind turbine converters.

1. Powerful partner network
2. Focused but flexible operations
3. Well proven base technology
4. Unrivalled applicability
5. The best power quality on the market





# verteco

Verteco Ltd

Yrittäjänkatu 15

FIN-65101

Finland

Phone: +358 6 282 8900

Fax: +358 6 282 8589

www: [www.verteco.com](http://www.verteco.com)